

Installation Instructions

Taylor Entrance Systems

Professional Remodeler Series

Pre-hung Replacement Unit

All steel frame, fully insulated with magnetic weather-strip and adjustable threshold.

The Professional Remodeler Series doors shall be (flush or embossed) 1.75" thick formed of 24-gauge galvanized steel on the Uni-Door and 22-gauge galvanized steel on the Stainable Steel door, stiffened, insulated and sound-deadened with an environmentally friendly solid urethane core blown at a density of 2.0 - 2.5 lbs./sq. ft. The doors shall be formed utilizing an exclusive unitized (2) two-piece steel construction for strength and durability. Door shall be fitted with 4.25" x 11.25" solid core wood lock block. Edge of door at lock block shall accept standard 1" x 2.25" rectangular face latch bolt or round face latch bolt. Door shall also have 12-gauge galvanized steel plates located at each hinge (three per door) to allow for fine adjustments after door is in place without removal of door from opening. Door bottom weather-strip retainer shall be roll formed from 22-gauge hot dipped galvanized steel and mechanically fastened to bottom member.

All surfaces of the door shall receive a factory prime finish for added protection. The primed surface shall be suitable for finish painting. The Stainable Steel door will be primed with a special beige primer that accepts stains or paint. Bottom weather-strip shall be a dual durometer vinyl extrusion that shall slide on or off the door without removing the door from the opening.

Replacement Door Measurements

Size	Width		Height	
	Min.	Max.	Min.	Max.
2'5" x 6'7"	29-5/8"	30-1/2"	80"	80-1/2"
2'7" x 6'7"	31-5/8"	32-1/2"	80"	80-1/2"
2'11 x 6'7"	35-5/8"	36-1/2"	80"	80-1/2"
5'2" x 6'7"	63-1/4"	64"	80"	80-1/2"
5'10 x 6'7"	71-1/4"	72"	80"	80-1/2"

Special sizes are available.

Important

Read these instructions completely before you begin installation. Always think "safety first". Use the proper tools and always wear safety glasses to protect your eyes.



Step 1

Check door opening for size and swing

Measure the height and width of your old door and check to see whether it swings to the right or to the left.

Check the size and swing of your new door and make sure it corresponds with your old door.

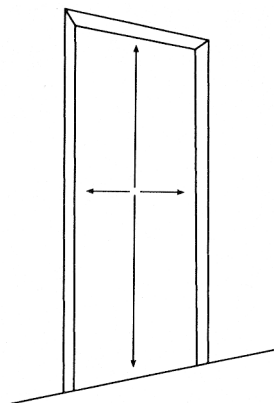

Step 2

Closer look at the door opening

Check the existing door jamb to make sure that it will receive a 1-3/4" door properly. Note: You may have to cut the rabbit out of the jamb.

Check the height of the header, it may need to be built down or cut to receive the door properly.

Check to see if the door casing is in good enough condition to be reused, or if it needs to be replaced.

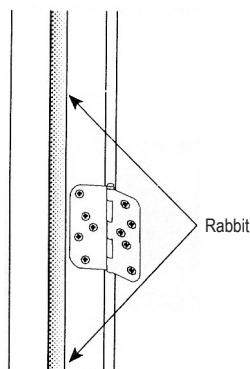

Step 3

Removal of the old door and hardware

Pull the hinge pins and remove the door from the jamb. Remove all hinges and lock strike from the inside of the door jamb.

Remove existing trim by scoring the paint joint on the dry-wall side of the trim. Then, with a putty knife, or thin chisel, pry from the door opening side so as you do not mar the drywall. Replace the trim if it is damaged.

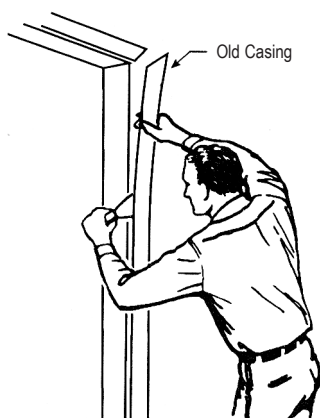

You may need to chisel a small amount of the jamb for threshold clearance.

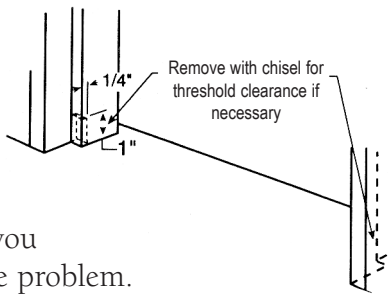

Check for any rotting or warping, this may be a sign of water leakage and you may want to investigate the problem.

Remove any old weather-stripping. Clean the floor and jamb or all dirt and old caulking.

Step 4

Double check the opening size

Check the opening for size again. With some older homes that have settled, the frame may bow inward a little.

You may need to trim a little off the rabbeted edge with your circular saw. (Note: Use a carbide blade in your skill saw because there may be old nails in the wood.)

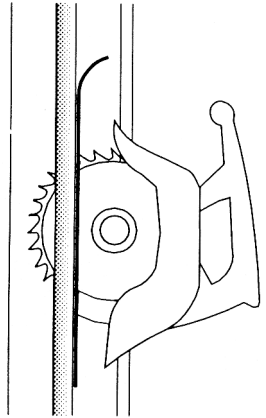

Step 5

Caulking threshold

Bring the new door to opening being careful not to scratch your new door.

Apply a heavy bead of caulk to the threshold and bottom of the door jamb as shown.

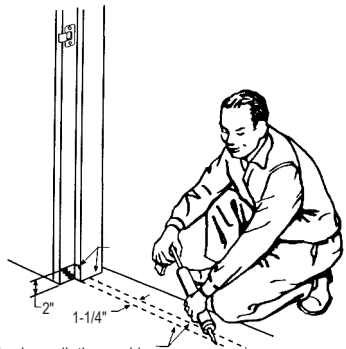

Apply caulk thoroughly to prevent water leakage

Step 6

Center door in opening

Center the door in the opening. Mark the center of the jamb and line it up with the center of the new door frame.



Tack two 6d nails in each corner to hold the door in place. Remove shipping brackets and plastic shipping protector. Check the door again for swing and centering.

Step 7

Anchoring the door

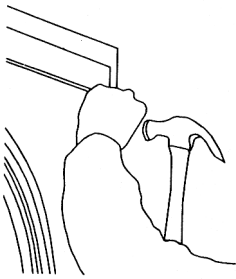

After the door is centered, anchor the door in place. First, nail through the metal door frame on the hinge side in the holes provided. Place a nail in the top hole of the lock side. Then close the door and eye the margin down the side, you may need to tap the frame a little to adjust it.

Run the six 2-1/2" wood screws provided into the two screw holes in each hinge. (Note: Be careful in tightening the screws as to not twist or bow the frame). Close the door and check the margin again. If the margin is fine, finish nailing the frame on the lock side checking margin as often as possible.

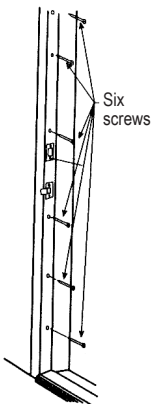
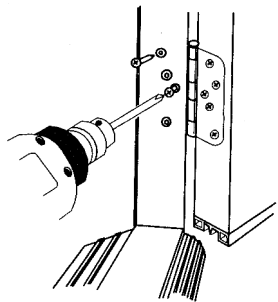

Drill pilot holes for the 2-1/2" wood screws for the lock side and run the screws in. You may need to work back and forth between the nailing and screwing, checking the margin between the frame and door.

Step 8

Adjusting the hinges for plumb

Open the door and loosen the four screws on all hinges on the door side. Slide the door up and down and/or move it in and out as necessary to square in the frame. Use a pry bar under the door to lift it, but take care to not damage the rubber weather-strip on the bottom of the door. You may want to mark the hinge with a pencil so you can always return to the original position.

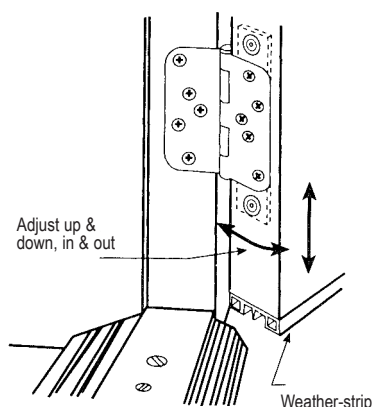

Step 9

Install locks and strike plate

Once the door is anchored and adjusted properly, install the locks and strike plate. The dead bolt has a small metal box, a receiver, for the dead bolt. Chisel out an opening for this and install the strike plate. The lock strike is adjustable, so you can adjust it for a proper fit later.

Next install the locks and dead bolt into the door. For installation instructions, refer to the manufacturer's instructions that come with them. Adjust the strike plate for proper fit.

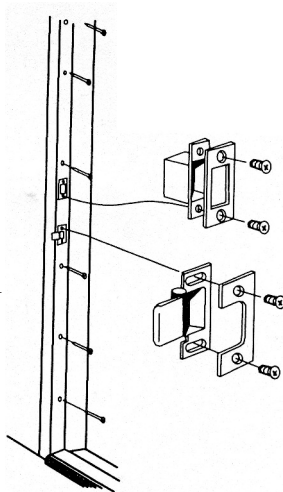

Step 10

Installing the weather-strip

Three wood stops with weather-strip are provided, two long and one short.

Measure between the wood jambs at the header and cut the strip to fit it.

Close the door and use it for a guide. Tack the strip in place and open the door. The magnetic weather-strip should make good contact with the door, but not bind or press too tight. Close the door and check contact. Finish nailing the header strip.

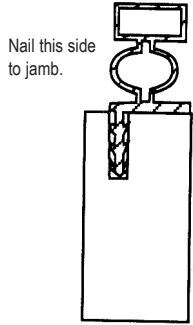
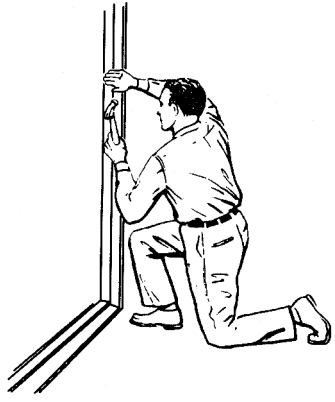

Now place a piece of paper or cardboard between the threshold and the jamb on the lock side.

Mark the angle of the threshold and cut the weather-strip accordingly. Measure the lock

side and cut the strip to fit, remember to cut the angle on the bottom to match the threshold. When you cut the rubber part of the strip, cut at the same angle as the wood to ensure a tight fit. Enclosed in the bag of parts is a small strip of rubber. It fits in the second channel behind the magnet at the bottom end of the weather-strip. This helps the strip maintain good contact with the base of the door. Using a universal office stapler, staple the magnet in place as shown. Make sure the weather-strip fits the header strip without gaps and nail in place.

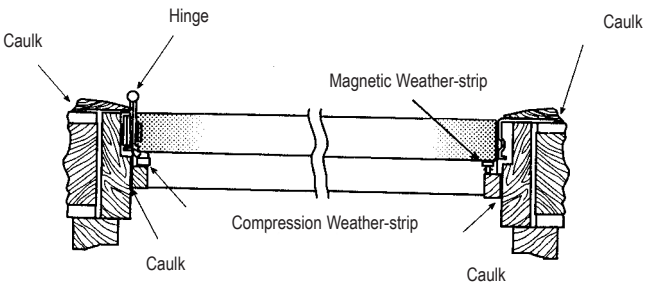
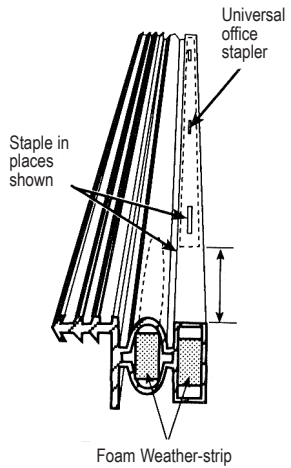

Install the hinge side compression type weather-strip in the same way you installed the lock side. Remember to first tack, make adjustments, and finish nailing.

Step 11

Adjusting threshold

Close the door to see how the threshold and bottom of the door meet. There are three sets of screws in the threshold. The three smaller screws are to raise and lower the sill. The larger screws are to anchor the assembly to the base.

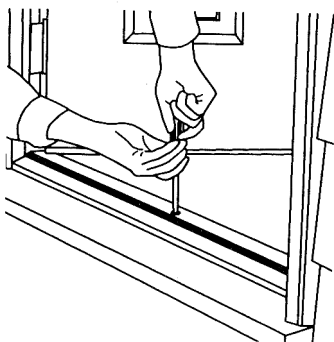

Loosen the anchor screws to allow movement. Then raise or lower the sill. Repeat the process until you are satisfied with the seal. Do not make it too tight or the seal will wear out - too loose and you will have air leaks. When you have a snug fit, tighten the anchor screws with a screwdriver.

Step 12

Final weather-strip

There are two more small pieces of weather-strip provided. The black compression type is for the hinge side, the one that resembles a piece of Velcro is for the strike side.

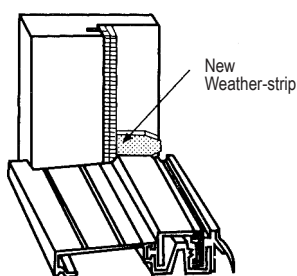
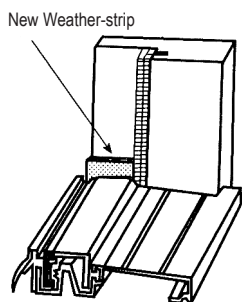

Peel the paper backing off and place these on the bottom of the jamb against the threshold as shown.

Step 13

Caulking the door

Caulk the door along the door stops and threshold as shown.

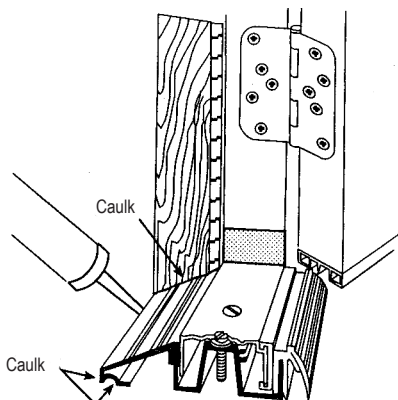

Step 14

Reinstalling trim

Replace inside door casing as necessary. Use existing holes if possible. It may be necessary to drill pilot holes through the steel frame of the new door in order to nail casing in place.



Finishing instructions

Your Taylor door has a factory applied primer coat of paint, the door should be free of dust and debris. For best results, the outside and inside and all edges of the door should be painted with a good quality exterior grade latex paint. CAUTION: Use of paints containing linseed oil, lacquer or alkyd base solvents voids the warranty on this door. Do not paint vinyl weather-strip. Allow paint to dry completely before closing door to prevent marking finish by weather-strip. All plastic trim and window lites should be painted or they will change color and may deteriorate with age. WARNING: Use of storm doors, unless well ventilated, may cause a heat build-up and a distortion of designs.

Limited Lifetime Warranty

The TAYLOR Professional Remodeler Series is warranted against defects in materials and workmanship for the life of the door. See your Taylor Door Dealer for specific details.

TAYLOR
Entrance Systems

AMERICA'S DOORMAKER

631 N. First Street • West Branch, MI 48661
800-248-3600 • www.taylordoor.com

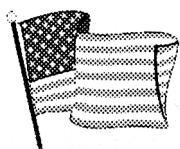

Made in the U.S.A.

04002001 Rev. 02/2013